

OWNER'S PURCHASE RECORD

Total Gym® Exerciser

Date Purchased _____

Purchased From _____

Serial Number _____

(located at the bottom of the support column)

CONTACTS

Customer Service, Parts, and Accessories - Call: **1.888.811.9740**

Additional Accessories - www.TotalGymCatalog.com

© 2007, 2002, 1999, 1998 Total Gym Fitness, LLC. All rights reserved. Total Gym® is a registered trademark. U.S. Patents #D 405,132, #5,967,955; ROC Patents #ND-060792; PRC Patent #ZL 97 2 28552.0. No part of this booklet may be reproduced or utilized in any form by any means, electronic, mechanical or otherwise, without express written consent of the copyright holder.



BH7367

1/07

total gym®

EXERCISE SYSTEM



OWNER'S MANUAL

For Models 2000, 3000, XL, and XLS

Congratulations on purchasing your new Total Gym®!

With this product in your home, you have everything you need to start your own workout program, to tone and strengthen the important muscle groups of your upper and lower body. This is vital for all of us, regardless of age, sex, or fitness level, and regardless of whether your primary goal is body sculpting, weight control, health maintenance, or more energy for daily activities.

Strength training not only tones and conditions the muscles we use every day to stand, walk, lift, and turn; it can actually transform our body composition. By reducing body fat and increasing the proportion of lean muscle in our bodies, strength training can effectively turn up our metabolic thermostat, so that we burn up to 30% more calories all the time, no matter what we're doing.

It's easy—all you have to do is spend 10 to 15 minutes a day on your Total Gym® to start realizing the benefits.

Be sure to read through this owner's manual carefully.
It is the authoritative source of information about your Total Gym®.

Table of Contents

Product Specifications	3
Safety Instructions	4
Set Up	5-7
Optional Accessories	8-10
Starting Out	11
Inspection, Maintenance & Storage	12-13
Exploded Drawing and Parts List	14
Work Out Progress Chart	15
Limited Lifetime Warranty	16
Total Gym® Starter Program	17-19
Owner's Purchase Record	back cover
Contacts	back cover

(Model XLS shown on cover)

PRODUCT SPECIFICATIONS

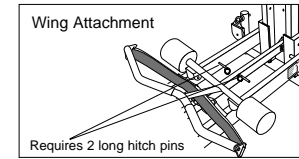

LENGTH: folded 51.5"
 in use 90"
 HEIGHT: folded 8.875"
 in use 43"
 WIDTH: 18.5"
 WEIGHT: 68 lbs.
 MAX. USER WEIGHT: 400 lbs.

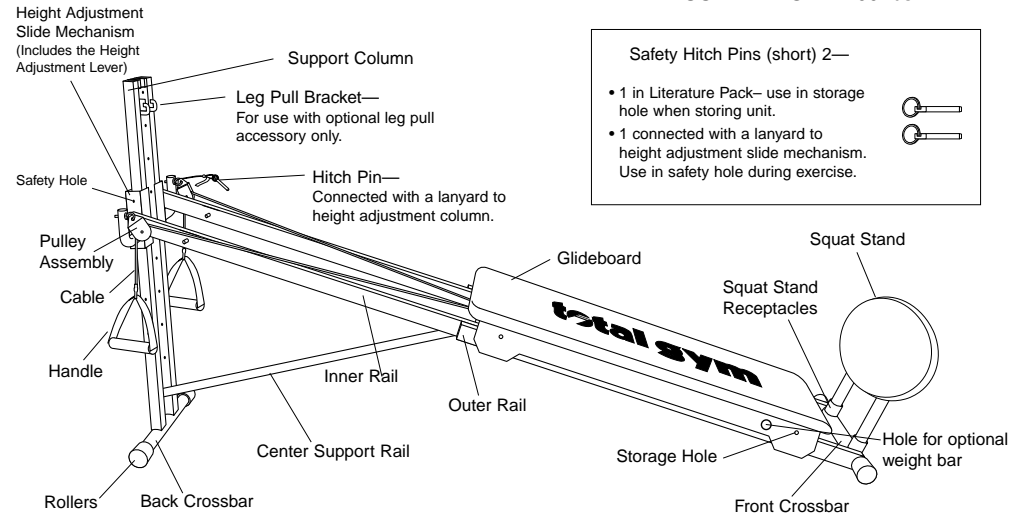

OPTIONAL ACCESSORIES AVAILABLE FOR PURCHASE (1.888.811.9740)

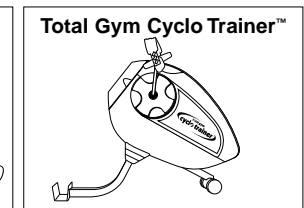
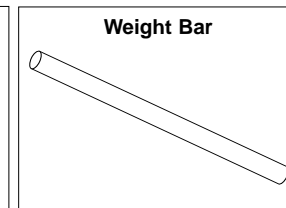
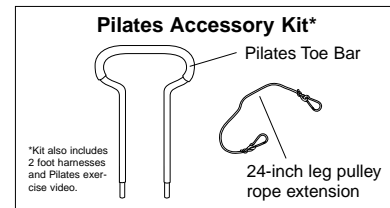
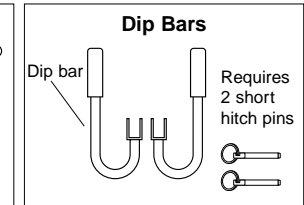
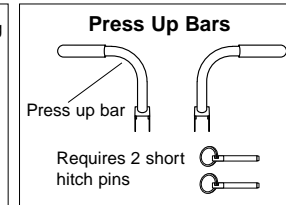
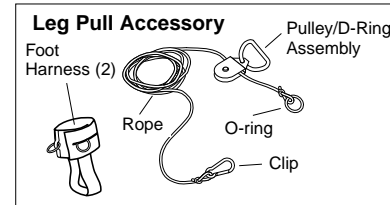

(Model XLS pictured above)

SAFETY

WARNING

FAILURE TO READ AND FOLLOW THE SAFETY INSTRUCTIONS IN THIS MANUAL MAY RESULT IN SERIOUS INJURY OR DEATH FROM FALLING, OVEREXERTION, STRAINED MUSCLES, OR PINCHED FINGERS.

Before beginning this or any exercise program, consult a physician or health professional, who can assist you in planning a program appropriate for your age and physical condition. This is especially important if you are over age 35 or have pre-existing health problems.

Do not overexert yourself. Stop exercising immediately and consult your doctor if you experience pain or tightness in your chest, irregular heart beat, shortness of breath, or if you feel faint, nauseous, or dizzy.

This product is designed for home use only. It is not intended for commercial or institutional use. Use only as instructed. **Do not stand on the product.**

Adult supervision is required whenever a child is on or near this exerciser.

Keep fingers, loose clothing, and hair away from moving parts.

Inspect your exerciser before each use to ensure proper operation. Do not use this equipment unless all moving parts are working properly. If any part is broken or missing, stop using your Total Gym® and contact Total Gym Customer Service at 1.888.811.9740.

Use only the accessory items recommended by the manufacturer.

Care should be taken at all times when **getting on and off** this or any exercise equipment. Falling on or off the product could result in injury, or possibly death.

SET UP

FULLY ASSEMBLED! • NO TOOLS REQUIRED!



Set up your Total Gym® in 5 easy steps.

WARNING

KEEP HAIR, FINGERS, LOOSE CLOTHING, CHILDREN AND PETS AWAY FROM HINGES AND OTHER MOVING PARTS TO AVOID SERIOUS INJURY. ALSO, BE SURE TO HAVE THE HEIGHT ADJUSTMENT LEVER PIN AND SAFETY HITCH PIN LOCKED IN PLACE BEFORE GETTING ON YOUR TOTAL GYM TO AVOID SEVERE INJURY.

Step 1

Lay shipping box flat and open carton top.

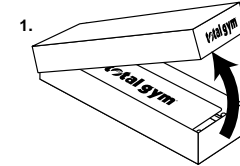

Step 2

Remove corner tape from the carton bottom (as indicated by the X's). Remove all packaging materials, including cardboard inserts, from your Total Gym®. Remove the squat stand from under the gym (as shown to the right) and install on opposite end into receptacles.

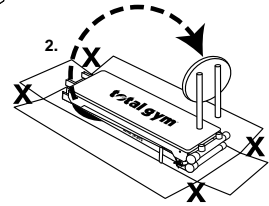

Step 3

Lift gym up from opposite end of squat stand. Make sure that it rests solidly on the squat stand. Remove the two accessories from under the bench.

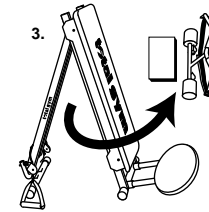

Step 4

Extend Total Gym® out in the following manner:

(4a) Place one hand on the edge of the frame. With your other hand, take hold of the support column and begin to pull it out until the frame is lying flat on the floor.

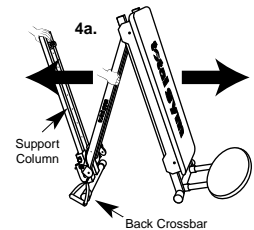

Be sure to support the frame in the center to avoid having the product drop suddenly onto the floor.

(4b) The spring-loaded pin on the right rail will automatically engage during set-up. This pin prevents the support column from collapsing when the height adjustment pin is locked into the bottom storage hole.

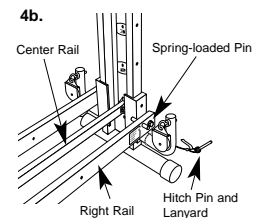

(See next page for additional set up information.)

Step 5

Raise the Total Gym® to the desired incline level by positioning one foot on the back crossbar to keep the product from lifting off the floor.

(5a) With one hand on a side rail, grasp the height adjustment lever on the height adjustment slide mechanism and raise to one of the lower levels.

(5b) Push the lever back to its original position (*it should be flat against the support column*). Slide the frame until you hear the lever pin *snap* into place. Look on the inside of the support column to make sure the lever pin is through the hole and locked into place. **Never sit or exercise on Total Gym® without the adjustment lever and safety hitch pin securely locked into place.**

(5c) Insert the safety hitch pin connected to the lanyard through the safety hole on the side of the height adjustment slide mechanism until it is through the support column. **Never sit or exercise on Total Gym® without the adjustment lever and safety hitch pin securely locked into place.**

(5d) Insert the *Training Deck* holder into the two holes located on the top of the support column.

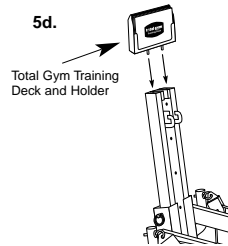
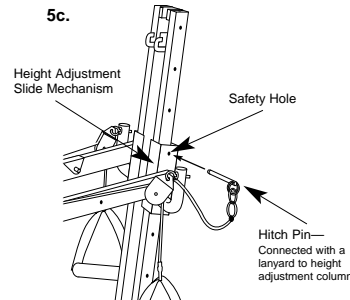
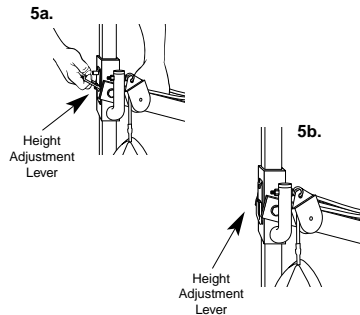

WARNING

BOTTOM HOLE IN THE SUPPORT COLUMN IS FOR *STORAGE ONLY*. ATTEMPTING TO EXERCISE WITH THE HEIGHT ADJUSTMENT LEVER PIN IN THIS BOTTOM HOLE POSITION WILL CAUSE THE SUPPORT COLUMN TO COLLAPSE FORWARD AND COULD RESULT IN SERIOUS INJURY.

FAILURE TO SECURELY LOCK THE HEIGHT ADJUSTMENT PIN AND SAFETY HITCH PINS INTO PLACE MAY RESULT IN SERIOUS INJURY OR EVEN DEATH.

SET UP IS COMPLETE!

Begin using Total Gym® at a low incline. As your fitness level increases, raise the incline to increase the intensity of your workout and improve your muscle strength.

If you have questions about your Total Gym®, please call Customer Service at 1.888.811.9740.

Be sure to check out the instructional video entitled "*Total Gym: Start It Up!*" full of valuable tips to get the most out of your new Total Gym®.

HOW TO INSTALL AND USE THE WING ATTACHMENT:

Pull ups:

1. Locate the holes at the top of the right and left rails on the support column end of the unit.
2. With the attachment angled **toward** the glideboard, line up the brackets on the attachment with the holes on the rails.
3. Insert the 2 long hitch pins through the holes on the attachment brackets and the hole on the rails as indicated by arrows in Fig. 1.
4. You are now ready to perform pull up and chin up exercises to work the arms, lats and back.

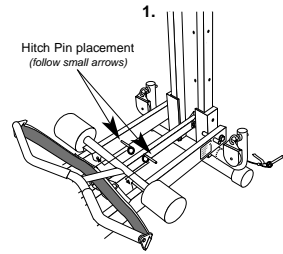

Leg Pull, Crunches, and Sit ups:

1. Locate the holes at the top of the right and left rails on the support column end of the unit.
2. With the attachment angled **away from** the glideboard, line up the brackets on the attachment with the holes on the rails.
3. Insert the 2 long hitch pins through the holes on the attachment brackets and the hole on the rails, as indicated by arrow in Fig. 2.
4. Insert feet under each angled "wing" of the attachment, with soles resting firmly on the strap. You are now ready to perform leg pulls, crunches and sit up exercises to work the abdominals, waist and legs.

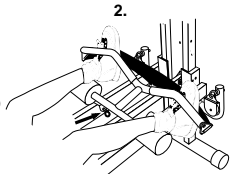

ALL HITCH PIN LOCATIONS

- One (1) short pin and two (2) long pins are held within the *Total Gym Training Deck* holder.
- One (1) short pin is connected by a lanyard to the height adjustment slide mechanism on the support column.

WARNING

FAILURE TO SECURELY LOCK THE SAFETY HITCH PINS INTO PLACE MAY RESULT IN SERIOUS INJURY OR EVEN DEATH.

OPTIONAL ACCESSORIES

Follow the instructions below on how to attach the optional accessories to your Total Gym®.

PRESS UP BARS (OPTIONAL)

1. Attach each press up bar to the frame with the short hitch pins included with your Total Gym®.

Note: Hitch pins are included with the press up bars. Simply line up each bar with the holes at the bottom of the frame.

2. Slide one short hitch pin through the hole of one of the press up bars and through frame. Repeat *Steps 1 and 2* for attaching the other press up bar. **Make sure to securely attach each press up bar to each side of the frame before using.**

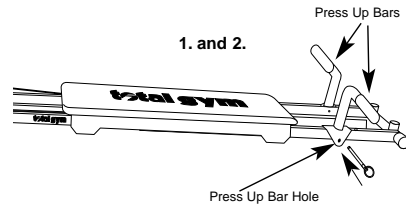
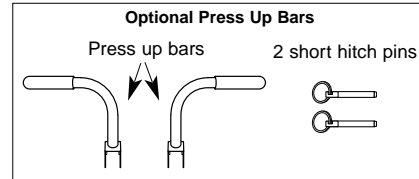

See *Total Gym: Start It Up!*, section "Optional Accessories" for tips on how to utilize the press up bars. Remove the press up bars when you are not exercising with them.

DIP BARS (OPTIONAL)

1. Attach each dip bar to the frame with the short hitch pins included with your Total Gym®.

Note: Hitch pins are included with the dip bars. Simply line up each bar with the holes in the upper portion of the bottom frame.

2. Slide one short hitch pin through the hole of one of the dip bars and through frame. Repeat *Steps 1 and 2* for attaching the other dip bar. **Make sure to securely attach each dip bar to each side of the frame before using.**

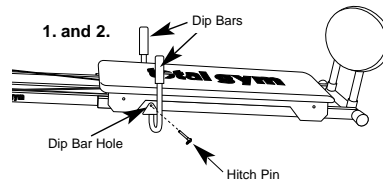
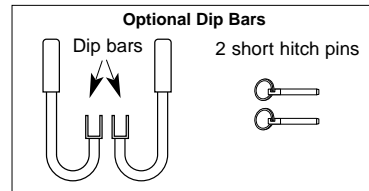

WEIGHT BAR (OPTIONAL)

1. Slide weight bar through the hole near the bottom of the Total Gym glideboard rails.
2. Add free weights equally and evenly to both sides of the weight bar when stacking weights. Weight clips must be installed on each side to prevent the weights from slipping off the bar. *Weights and clips not included.*

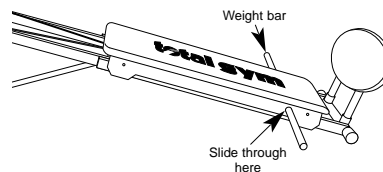

OPTIONAL ACCESSORIES (continued)

LEG PULL (OPTIONAL)

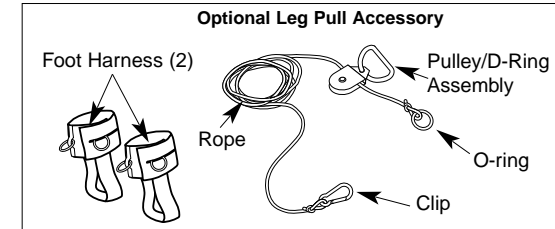

1. Detach the pulley mechanism from the hook on the underside of the glideboard.
2. Connect the D-ring/pulley combination of your leg pull accessory to the leg pull bracket on the support column.
3. Next, connect the O-ring (the one that is connected to the rope) to the hook on the underside of the glideboard.
4. Attach the foot harness to one of your feet by placing your foot in the harness so the sewn-in-ring is on the bottom of your foot. Pull tightly on the belt so the harness is secure.
5. Position yourself on the glideboard correctly for the specific exercise you want to perform. See *Total Gym: Start It Up!*, section "Optional Accessories" for tips on how to utilize the leg pull accessory.

Connect the clip on the end of the rope to an O-ring on the harness attached to your foot. Depending on the exercise you are performing, connect the clip to the proper O-ring. You are now ready to exercise using the leg pull accessory.

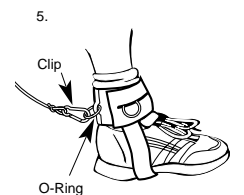
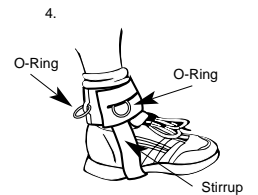
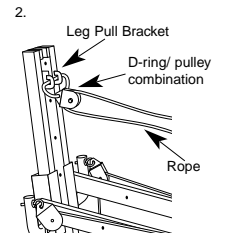

OPTIONAL ACCESSORIES (continued)

PILATES KIT (OPTIONAL)

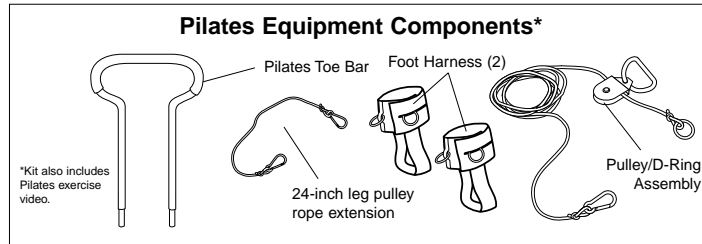

To begin your Pilates Exercise Program carefully follow the assembly instructions below.

1. Insert Pilates Toe Bar into squat stand receptacles

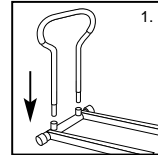

2. Assemble Pilates 24-inch leg pulley rope extension

- Detach the pulley mechanism from the hook on the underside of the glideboard.
- Next, connect the D-ring/pulley combination of your leg pull accessory to the leg pull bracket on the support column.
- Attach the foot harnesses to your feet by placing your foot in the harness so the sewn-in-ring is on the bottom of your foot. Pull tightly on the belt so the harness is secure.
- Connect the clip on the end of the leg pulley rope to the O-ring on one of the foot harnesses.
- Connect one end of the Pilates 24-inch rope to the O-ring on the leg pulley rope.
- Next, connect the other end of the Pilates 24-inch rope to the O-ring on the other foot harness.

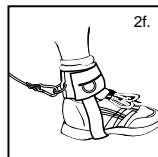
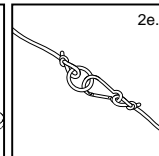
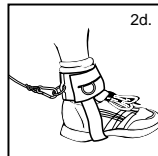
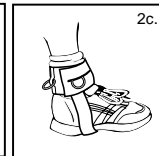
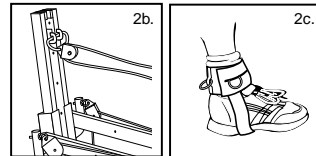

You are now ready to begin your Pilates exercise program.

STARTING OUT

Wear athletic shoes and comfortable light clothing when exercising on your Total Gym®. Do not exercise barefoot. Check your exerciser before use to ensure that all the parts are in place and working properly (see page 12 for details of the inspection process). **Adult supervision is required whenever a child is on or near this exerciser.**

Begin using the product at a low incline. As your fitness level progresses, increase the incline to increase the intensity and improve your muscle strength. Don't be in a hurry to exercise at a high intensity level; start out easily and build gradually. Total Gym® is as easy as 1-2-3 to use, so read on.

1. Important Things to Remember When Using Total Gym®

- Always have control of the glideboard before getting on and off the exerciser.
- Keep your feet on the floor when getting on and off the exerciser. Only remove them from the floor for the duration of the exercise.
- If you are using the handles, hold onto them as you get on and off the glideboard.

2. Exercising with the Handles Only

Grasp the handles which are attached to the cable and slide the glideboard to a position in which you can comfortably sit or lay down when performing the desired exercise. Be sure to keep your feet on the floor until you are in the correct position for the specific exercise. Then, if the exercise calls for your feet to be off the floor, place your feet as specified in the instructions.

3. Exercising with the Squat Stand Only

Slide the glideboard to a position in which you can comfortably sit or lay down when performing the desired exercise. Keep your feet on the ground until you are in the correct position and feel comfortable. Then, place your feet in the proper position and begin to exercise.

When starting your exercise program, begin with the basic exercises in the *Training Deck* included with your Total Gym® to familiarize yourself with the movements. Use the lowest incline level to start with—you can work up to a higher incline level in the weeks and months to come.

For the specific Total Gym® exercises and programs, follow the exercises in the *Total Gym Training Deck* included with your Total Gym®.

INSPECTION AND MAINTENANCE

INSPECT YOUR TOTAL GYM® PRIOR TO EACH USE

Before using your Total Gym® for your workout session, be sure to make the following inspection:

- Make sure the equipment is fully opened and sitting on a solid level surface with plenty of clearance on all sides.
- Check that the pulley is attached securely to the hook on the front underside of the glideboard, as well as the uprights on the support column.
- Make sure that the eyebolts are securely fastened to each upright on the support column.
- Check that the cables are traveling correctly in the groove of each pulley.
- Make sure the cable is securely fastened to each hand grip.
- Check the cable for signs of wear and tear.
- Check that the squat stand is installed correctly in the squat stand receptacles.
- Make sure the glideboard is gliding smoothly along the frame.
- Make sure all the safety hitch pins and height adjustment pin are securely in place and locked into position.

ROUTINE MAINTENANCE

- Wipe down your Total Gym® after each use with a clean, damp (not wet) cloth. Do not leave towels or workout clothing laying or hanging on the equipment.
- Periodically check the following parts for signs of fraying or other wear: the cable, the pulleys, the wheels, the glideboard, the squat stand and the frame. If a part needs replacement, do not use the equipment until it is repaired or replaced.
- Periodically remove the glideboard to clean rails and glideboard wheels. See page 13, section “To Remove the Glideboard”, for details.

TO STORE YOUR TOTAL GYM®

Follow these easy steps to store your Total Gym® properly:

1. First, remove all accessories and attachments.
2. Install a safety hitch pin (short) into the storage hole on the glideboard.

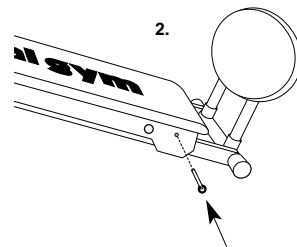

(Continued...)

3. Position one foot on back crossbar to keep the product from lifting off the floor. (a) With one hand on the frame, grasp the height adjustment lever and lower the frame until it rests on the back crossbar. (b) Then, push the lever back to its original position.

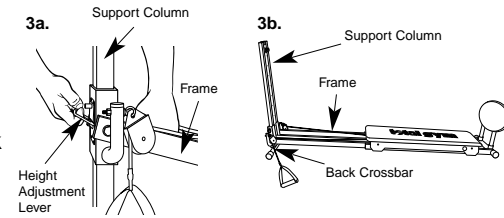

(It should be flat against the support column.)

4. Pull the spring-loaded pin (red knob) to disengage it and lower the support column onto the center rail.
5. (a) With caution, to avoid pinched fingers or hands, lift up at the center of the frame and fold the exerciser together. (b) When it is completely folded, the exerciser should be at a 90 degree angle with the floor. The exerciser will rest on the squat stand for support.

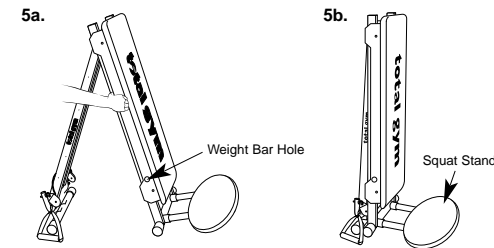
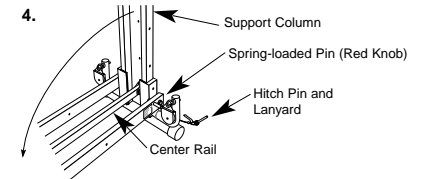

6. You can store the exerciser in a closet or against the wall. To store it under a bed, simply lower the exerciser to the floor, remove the squat stand, and roll under the bed.

⚠ CAUTION

USE CAUTION WHEN FOLDING THE EXERCISER—SERIOUS INJURY COULD RESULT FROM PINCHED FINGERS OR HANDS.

TO REMOVE THE GLIDEBOARD

You can also remove the glideboard if you need to fit the exerciser under a narrow space (between 6” and 8”).

1. Remove the short safety hitch pin from the storage hole.
2. Disconnect the pulley from the hook on the underside of the glideboard.
3. Next, lift up the glideboard and slide it off the frame of the exerciser. When the bench is completely off the exerciser, set it aside.
4. Next, lower the exerciser to the floor, remove the squat stand, and roll the exerciser under the desired area.

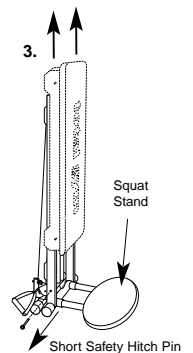

⚠ CAUTION

THE GLIDEBOARD WEIGHS APPROXIMATELY 22 LBS. USE CAUTION WHEN LIFTING IT OFF OF THE EXERCISER. LIFTING INCORRECTLY MAY RESULT IN USER INJURY.

LIMITED LIFETIME WARRANTY

Total Gym Fitness, LLC warrants that under normal residential use, Total Gym® is free from defects in material or workmanship. The duration of coverage of this warranty varies depending on the part of equipment that is defective (see chart below). This warranty is effective from the date of original purchase. **This warranty is valid only for the original owner of this exerciser and is not transferable.**

Part	Warranty	Coverage
Frame	Lifetime	Replace frame that is structurally defective with a new frame or replace the entire unit.
All other parts (includes wheels, pulleys, cables)	6 months	Repair or replace defective part or product.

The Total Gym Fitness, LLC obligation under this warranty is limited to replacing the defective part(s); or, at its option, repairing or replacing (or refund in its sole discretion) the product. **For service on this equipment, call 1.888.811.9740. Improper or incorrectly performed repairs voids this warranty.**

This warranty does not cover product damage attributable to misuse, abuse, neglect, accidents, unauthorized alterations or repairs, failure to follow manufacturer's directions for use, improper maintenance, vandalism, usage for commercial or rental purposes, or "ordinary wear and tear". This warranty does not cover any separately sold items, parts, or accessories.

Except for other written warranties issued by Total Gym Fitness, LLC applicable to new Total Gym Fitness, LLC product or parts, no other express warranty is given or authorized by Total Gym Fitness, LLC. Any implied warranty of merchantability or fitness for a particular purpose is limited to the duration of this warranty. No agent or retailer of Total Gym Fitness, LLC has authority to modify this warranty in any respect.

Total Gym Fitness, LLC may not be held liable for indirect or consequential damages arising out of use or performance of this product. These include—but are not necessarily limited to—loss of use of the product; loss of time, enjoyment, or revenue; inconvenience; installation or removal costs; or other incidental or consequential damages.

Some states do not allow limitations on how long an implied warranty lasts, or the exclusion or limitation of incidental or consequential damages, so the above limitation may not apply to you. This warranty gives you specific legal rights; you may also have other rights which vary from state to state.

For service, call our Customer Service Department at: 1.888.811.9740

TOTAL GYM® STARTER PROGRAM

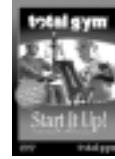

The following workout, for men and women of all fitness levels, will get you acquainted with your new Total Gym. You can view this workout in its entirety as a work-along program in your *Total Gym: Start It Up! Video*. Follow this guide as you work-along or use it as a reference when you can't watch the workout.

This starter program has been designed as a circuit training program to maximize cardio and strength training benefits. Start off with 15 repetitions of each exercise, moving from one to the other with little or no rest in between. If you find that 15 reps are too easy, increase the incline level on your Total Gym. If you are struggling with 10-12 reps, then decrease your incline level.

 See *Total Gym: Start It Up!* video for the work-along version of this program.

1. Squats



2. Single Leg Squats



3. Pull Ups



(Total Gym Starter Program continues on pages 18 - 19.)

4. Leg Curls (Seated or Lying)



A

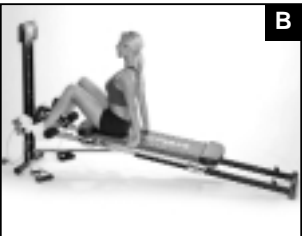

B

5. Cross Cable Row



A



B

6. Bicep Curl



A



B

10. Pullover



A



B

11. Pullover with Crunch



A



B

12. Lying Triceps Extension



A



B

7. Outer Hip & Thigh



A



B

8. Oblique Twister



A



B

9. Seated Chest Press



A



B

13. Shoulder Press



A



B

14. Core Extension



A



B

15. Toe Touch Stretch

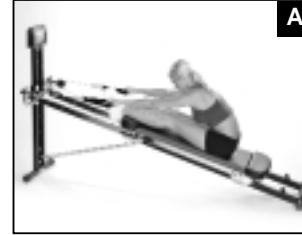

A